

Index	Alteration	Date	Sign.

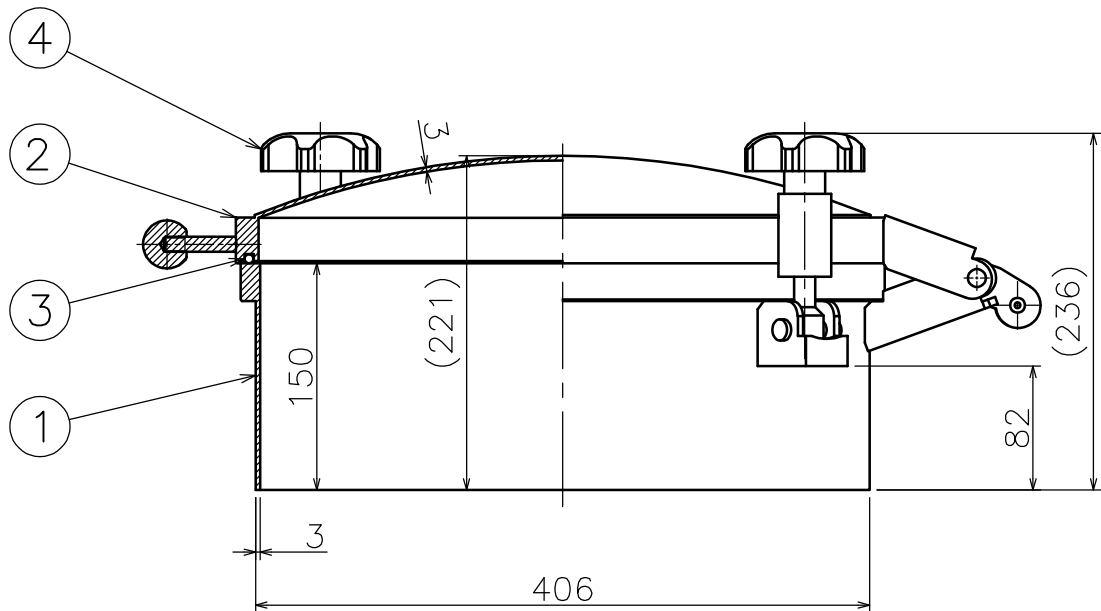

* 2	EPDM , NBR , FPM , Q(Silicone)
* 1	AISI 304 , AISI 316L

4	ハンドル	AISI 304	4	
3	パッキン	* 2	1	
2	カバー	* 1	1	
1	フレーム	* 1	1	
No.	NAME OF PART	MATERIAL	Q' ty	REMARKS

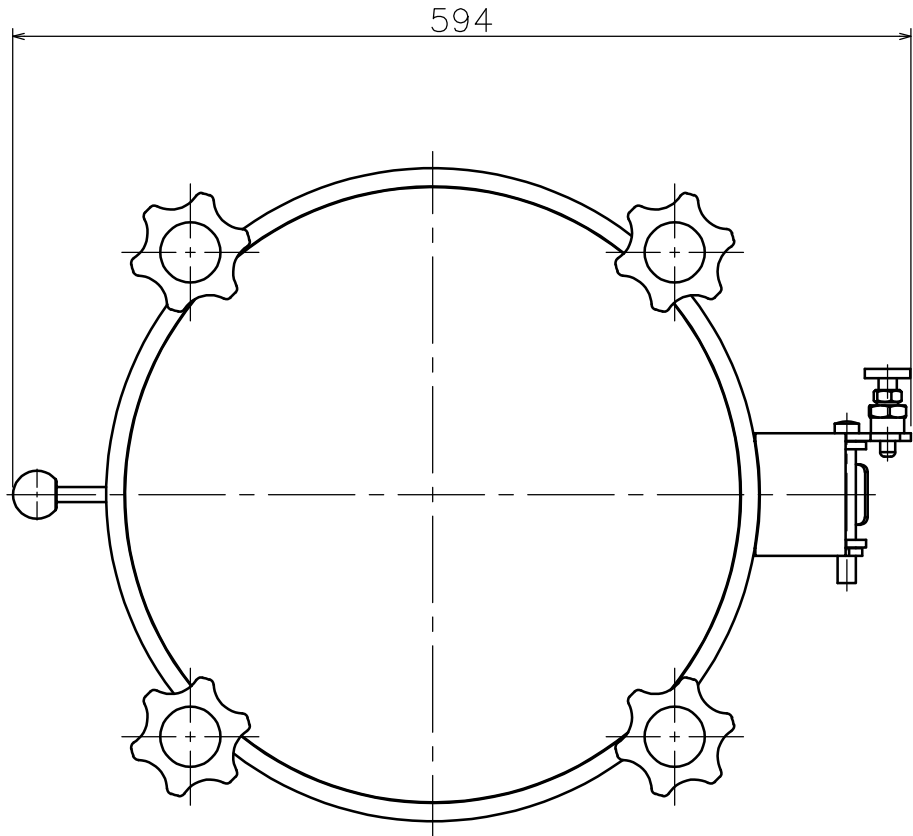

DAIWA

Daiwa Hanbai Corporation Ltd.

TITLE アルファ・ラバル製 マンホールカバー
LKDC-LP 400

SIGN. K.KANAI DATE 2020.10.23 SCALE 1 : 5

APPR. K.MURAKAMI DATE 2020.10.23 DRWG.No

LKDC-LP-400

Index:

